

RF/Microwave Amplifier

Available as:

TM3126, 4 Pin 0.500" TO-8 Can (T4)
 TN3126, 4 Pin 0.450" Sq. Surface Mount (SM3)
 BX3126, SMA Connectorized Housing (H1)



Features

- **Low Noise Figure : 1.2 dB**
- **No External Circuitry Needed**
- **RoHS Compliant Model Available**
- **Unconditionally Stable**

Technical Specifications

Characteristic	TYPICAL Ta = +25 °C	MIN/MAX Ta = -55°C to +85 °C
Frequency	200 – 500 MHz	200 – 500 MHz
Gain (dB)	21	19.5 Min.
Power @ 1 dB Comp. (dBm)	+26.5	+25 Min.
Reverse Isolation (dB)	-30	--
VSWR	In	1.5:1
	Out	1.5:1
Noise Figure (dB)	1.2	2.5 Max.
Power	Vdc	+15
	mA	165
		175 Max.

- 1) Care should always be taken to effectively ground the case of each unit
- 2) Typical values are measured at 25°C, but not guaranteed.
- 3) Package drawings below are for reference only.

Typical Intermodulation Performance at 25 °C

Second Order Harmonic Intercept Point:	+48 dBm (Typ.)
Second Order Two Tone Intercept Point:	+43 dBm (Typ.)
Third Order Two Tone Intercept Point:	+33 dBm (Typ.)

Note:
Intercept Values Measured at 400 MHz.

Absolute Maximum (No Damage) Ratings

Operating Temperature	-55°C to +100 °C
Storage Temperature	-62°C to +125°C
Case Temperature	+125 °C
DC Voltage	+18 Volts
Continuous RF Input Power	+18 dBm
Short Term RF Input Power	200 Milliwatts (1 Minute Max.)
Maximum Peak Power	0.5 Watt (3 μsec Max.)

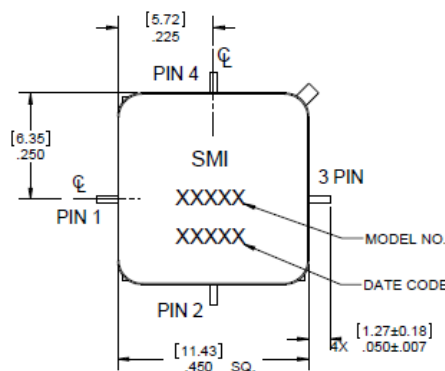
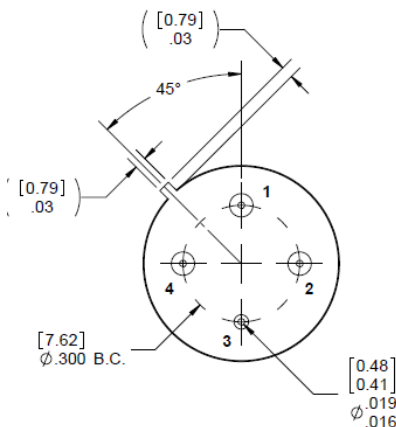

Typical Performance Graphs

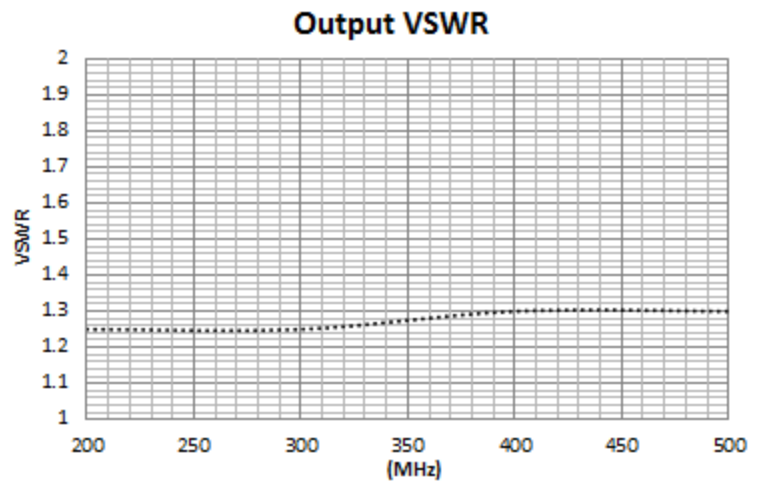
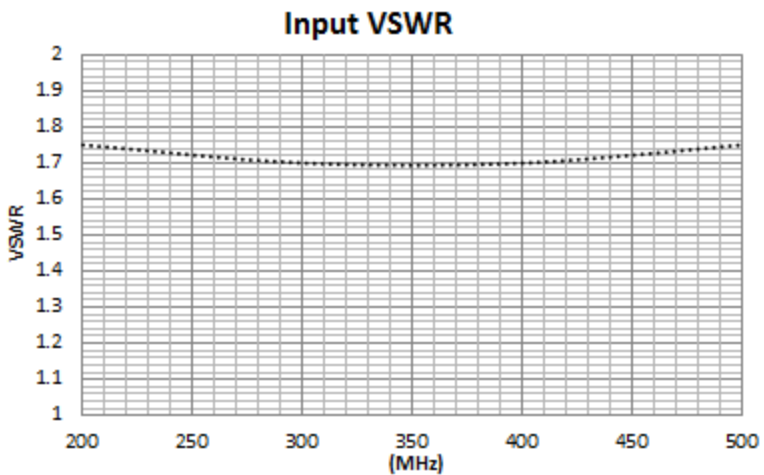
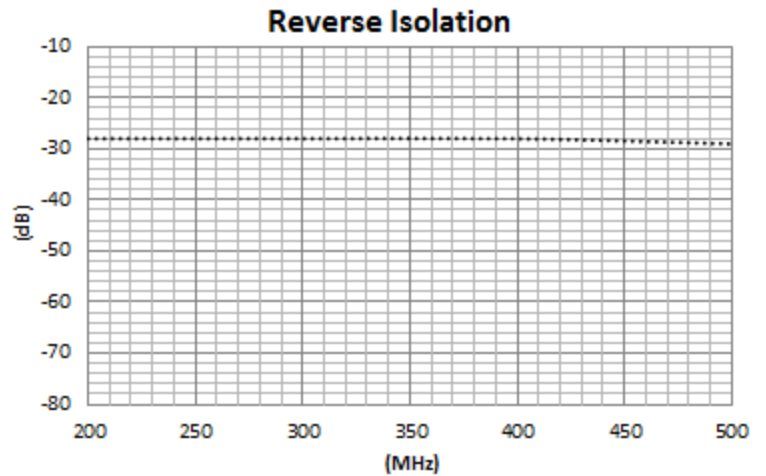
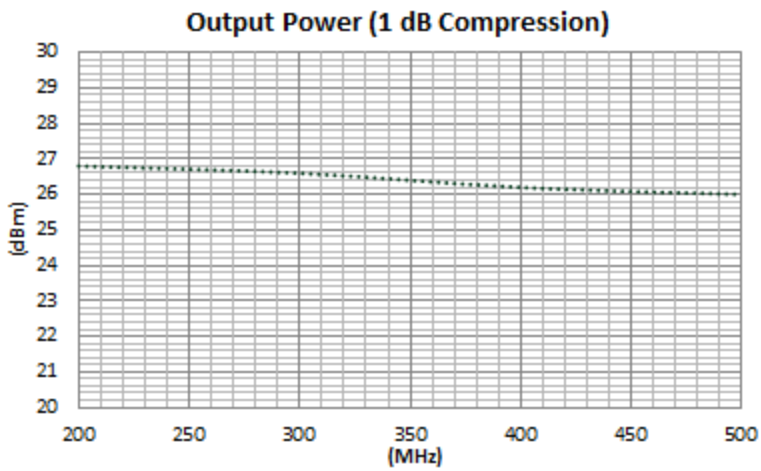
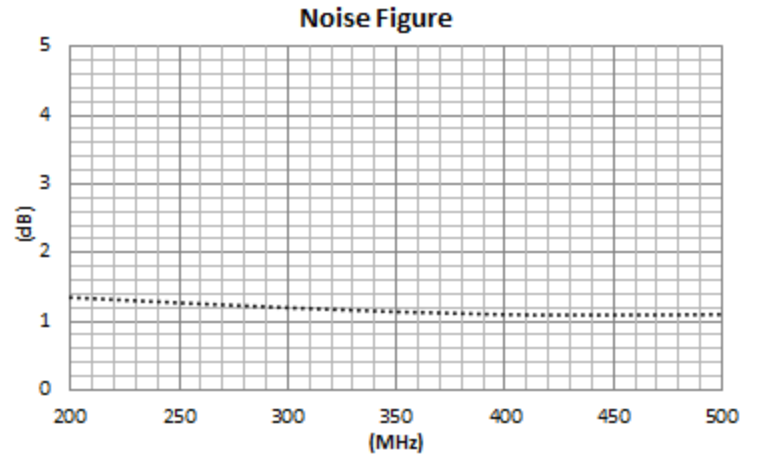
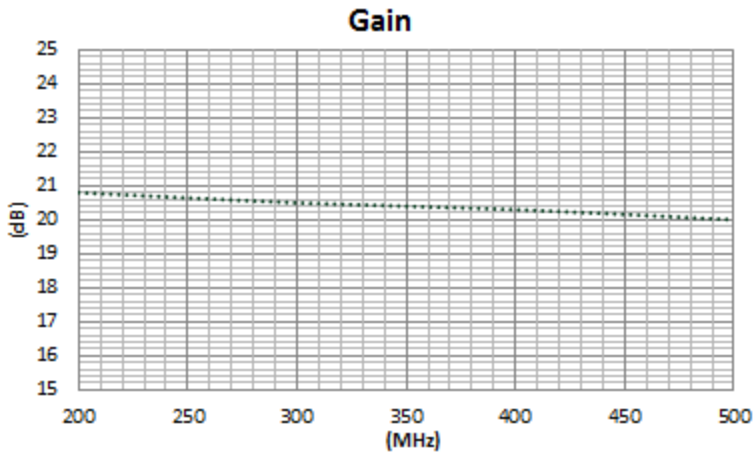

Instructions

Grounding Instructions	Care should be taken to effectively ground each unit.
Revisions	API reserves the right to make revisions to both product and/or the information contained within their datasheets without advanced notice.
Min./Max. Values	Specifications are guaranteed when tested in a 50 Ω (ohm) system.
Typical performance graphs and values are measured at 25°C, but not guaranteed.	

1) Outlines drawings below are for reference only.

NOTES:

1. HOUSING: ALUMINUM
2. FINISH: NICKEL

