

RF/Microwave Amplifier

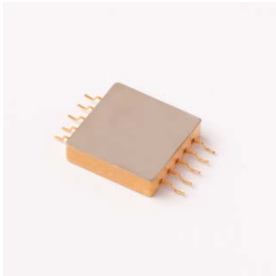

Features

- **Low Noise Figure : 1.2 dB**
- **No External Circuitry Needed**
- **RoHS Compliant Model Available**
- **Unconditionally Stable**

Technical Specifications

Characteristic		TYPICAL Ta = +25 °C	MIN/MAX Ta = -55°C to +85 °C
Frequency		1000 – 1500 MHz	1000 – 1500 MHz
Gain (dB)		18	16.5 Min.
Power @ 1 dB Comp. (dBm)		+21.5	+20 Min.
Reverse Isolation (dB)		-25	--
VSWR	In	1.5:1	2.0:1 Max.
	Out	1.5:1	2.0:1 Max.
Noise Figure (dB)		1.2	2.5 Max.
Power	Vdc	+15	+15
	mA	115	135 Max.

Typical Intermodulation Performance at 25 °C

Second Order Harmonic Intercept Point:	+50 dBm (Typ.)
Second Order Two Tone Intercept Point:	+43 dBm (Typ.)
Third Order Two Tone Intercept Point:	+33 dBm (Typ.)

Note:
Intercept Values Measured at 1250 MHz.

Absolute Maximum (No Damage) Ratings

Operating Temperature	-55°C to +100 °C
Storage Temperature	-62°C to +125°C
Case Temperature	+125 °C
DC Voltage	+18 Volts
Continuous RF Input Power	+18 dBm
Short Term RF Input Power	200 Milliwatts (1 Minute Max.)
Maximum Peak Power	0.5 Watt (3 µsec Max.)

- 1) Care should always be taken to effectively ground the case of each unit
- 2) Typical values are measured at 25°C, but not guaranteed.
- 3) Package drawings below are for reference only.

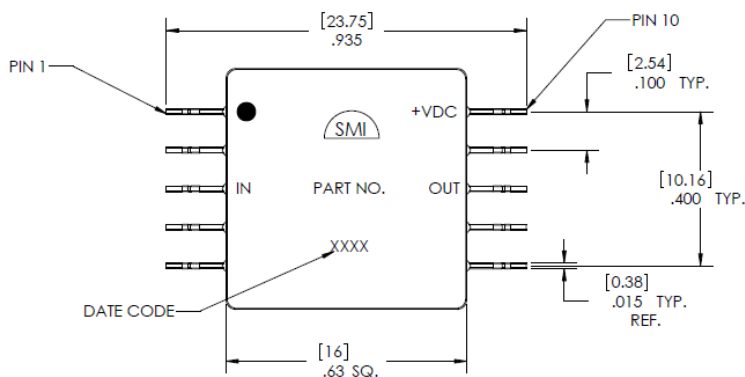

Typical Performance Graphs

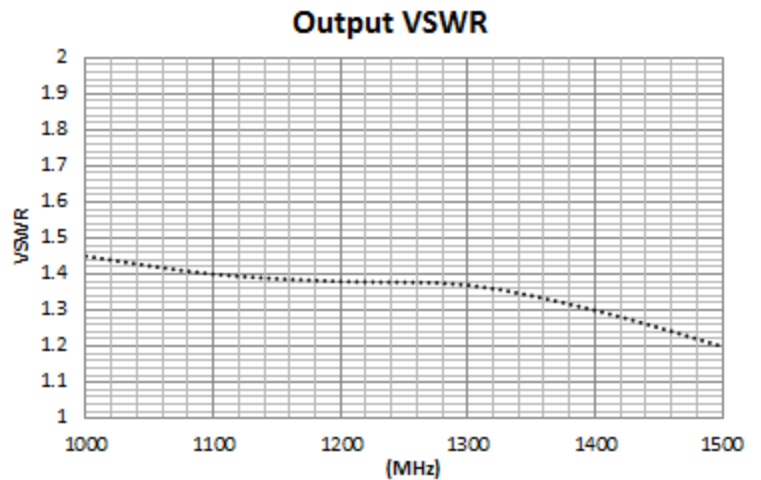
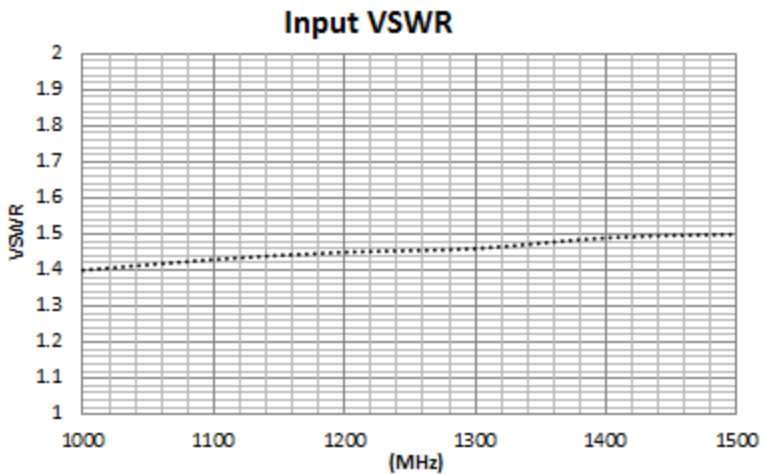
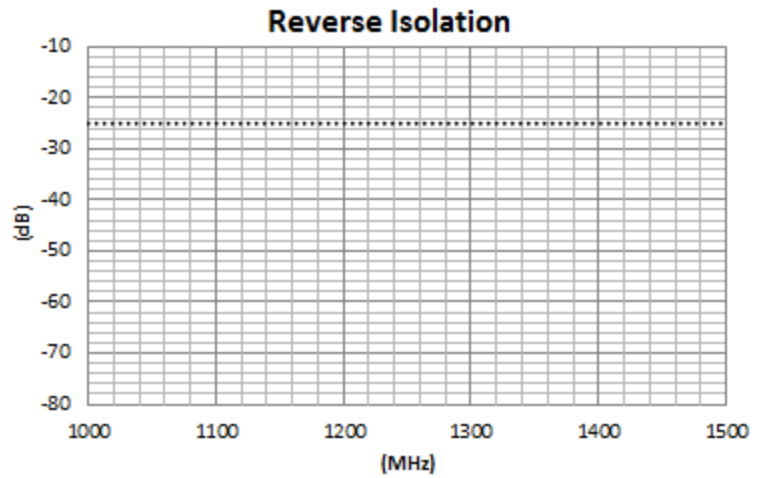
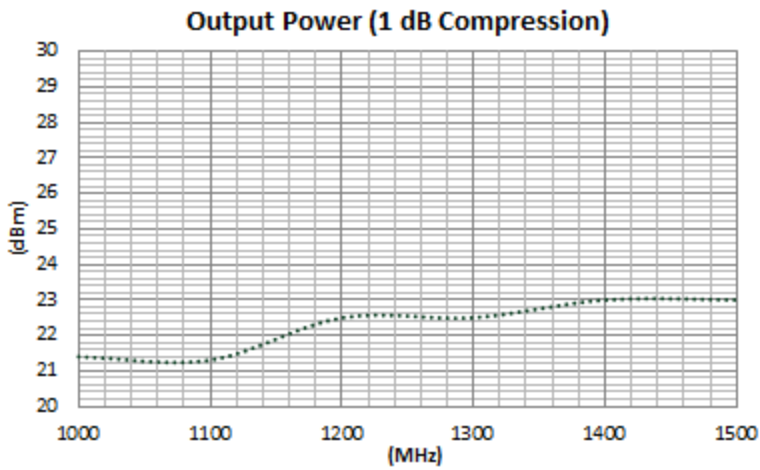
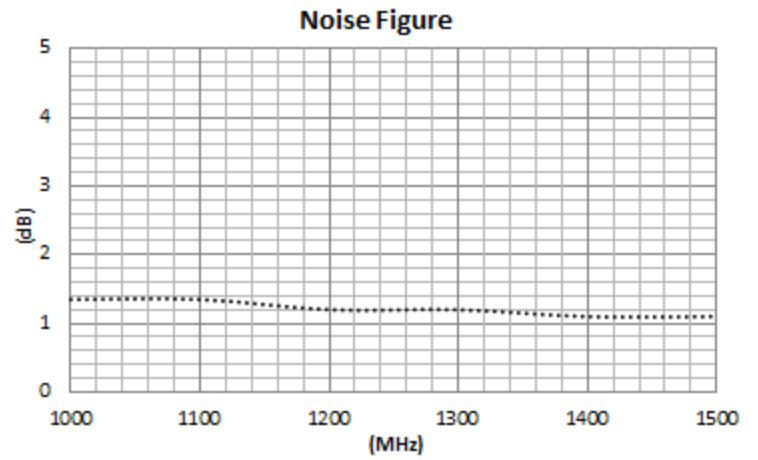
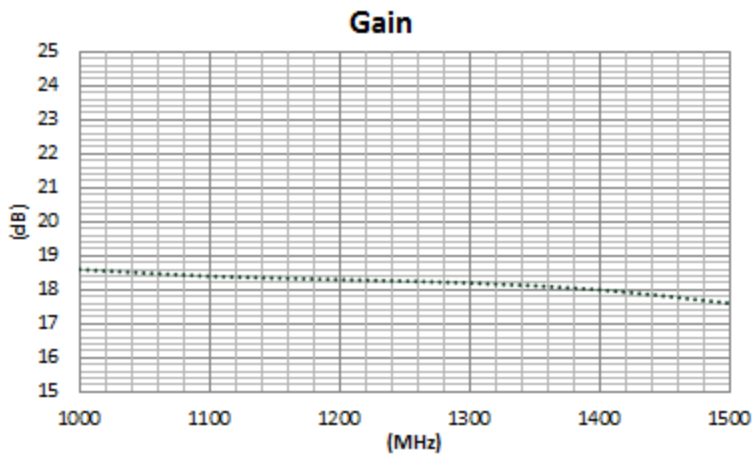

Instructions

Grounding Instructions	Care should be taken to effectively ground each unit.
Revisions	API reserves the right to make revisions to both product and/or the information contained within their datasheets without advanced notice.
Min./Max. Values	Specifications are guaranteed when tested in a 50 Ω (ohm) system.
Typical performance graphs and values are measured at 25°C, but not guaranteed.	

1) Outlines drawings below are for reference only.

HOUSING: 70/30 CN/NI
ELECTRONIC GRADE

