

DUST CAP SMA, TNC, TYPE N, 2.4mm, SMP

CHAIN OPTION



MODELS: 7602, 7603, 7604, 7605, 7606, 7607

SPECIFICATIONS:

Mechanical:

SMA Connectors
Mates with MIL-STD-348
Coupling Nut _____ Passivated Stainless Steel
Housing _____ Passivated Stainless Steel
Type N & TNC Connectors _____ Nickel Plated Brass
Mates with MIL-STD-348
2.4mm Connector _____ Passivated Stainless Steel
(Mates with 1.85mm & V* Connectors)
SMP Connector _____ Gold Plated Beryllium Copper
(Mates with GPO** Connectors IAW MIL-STD-348)
Bead Chain _____ Passivated Stainless Steel

*V is a trademark of Anritsu Corp.
**GPO is a trademark of Corning Gilbert Inc.

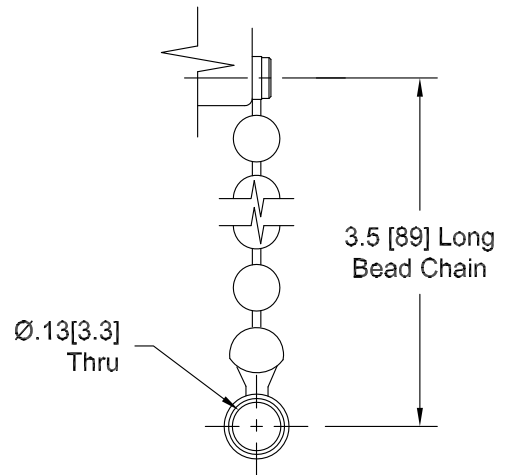

CHAIN DETAIL

HOW TO ORDER:

Model Number: **760XY**

Base Number | Style
See Below | = No Chain
C = Chain Included

Model Number: **7603**
SMA Male Connector
Scale: 2:1

Model Number: **7606**
2.4mm Male Connector
Scale: 2:1

Model Number: **7607**
SMP Female Connector
Scale: 4:1

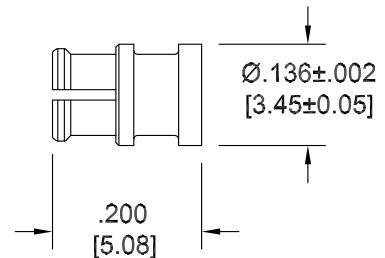
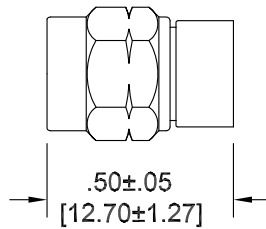
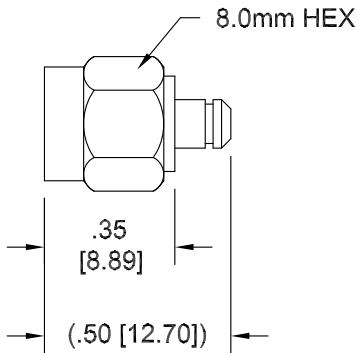

Model Number: **7604**
Type N Male Connector
Scale: Full

Model Number: **7605**
Type N Female Connector
Scale: Full

Model Number: **7602**
TNC Male Connector
Scale: Full

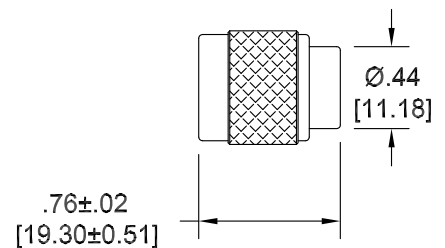
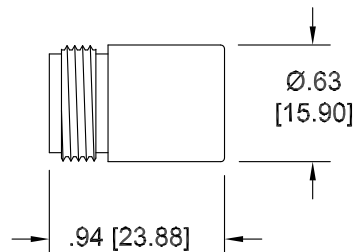
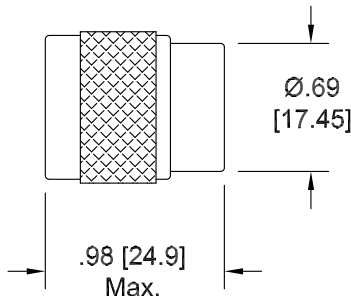

Note: Dimensions in Brackets are Expressed in Millimeters and are for Reference Only.
Design specifications are subject to change without notice.
Contact factory for technical specifications before purchasing or use.