

Switched Multiplexer with Integrated LNA

Features Sub-Octave Filter Bands for Excellent Harmonic Rejection

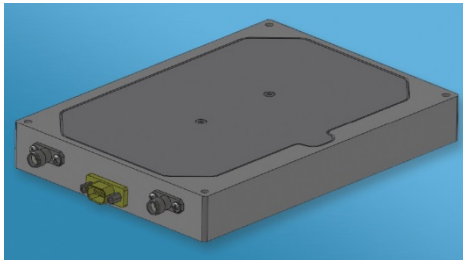

Features

- Broadband Performance
- 4-Channel Band Selection
- Low Noise Figure
- High Isolation & Harmonic Rejection
- Fast Switching
- Low DC Power Consumption (5.25 Watts)

Broadband integrated switched multiplexer with LNA for EW and ELINT applications, features sub-octave filter bands for excellent harmonic rejection. Any combination of the 4 frequency bands are selectable within 100 ns. Suitable for agile receiver front ends & direction finding systems.

Parameter	Performance	
Input Frequency Range	2 – 18 GHz	
Filter Characteristics	Frequency GHz	Stopband GHz
Band 1	2.0 - 3.5	DC - 1.7, ≥ 4.0
Band 2	3.5 - 6.0	DC - 3.0, ≥ 6.9
Band 3	6.0 - 10.4	DC - 5.1, ≥ 12.0
Band 4	10.4 - 18.0	DC - 8.8, ≥ 20.7

Input VSWR	2.0:1 max
Nominal Gain	23 dB
Channel Off Isolation	60 dB min.
Noise Figure	5 dB max @ +25°C
Harmonic Rejection	70 dBc min
Output 1 dB Compression	+10 dBm min.
Maximum input w/o damage	1 Watt CW
Band Select Switching Speed	100 nanoseconds max
RF Connectors	SMA (f)
DC Connector	9 Position Micro-D Receptacle
Operating Temperature	-40°C to +85°C

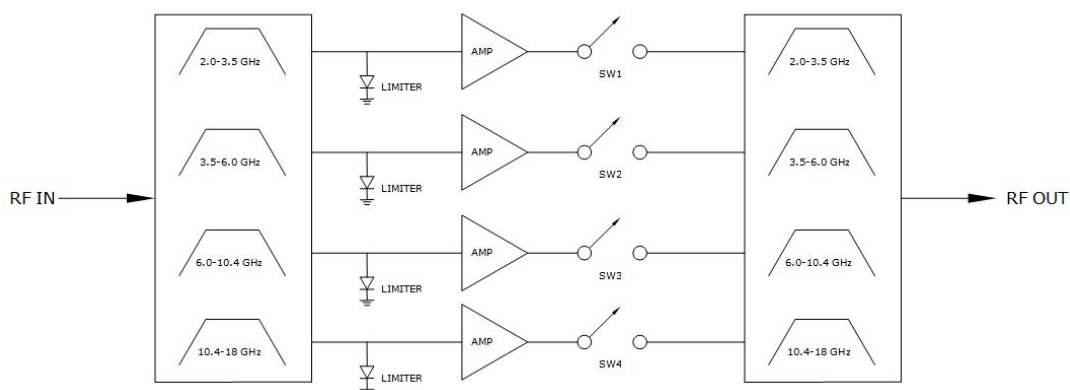

Switched Multiplexer with Integrated LNA

Features Sub-Octave Filter Bands for Excellent Harmonic Rejection

Typical Performance

All Channels On

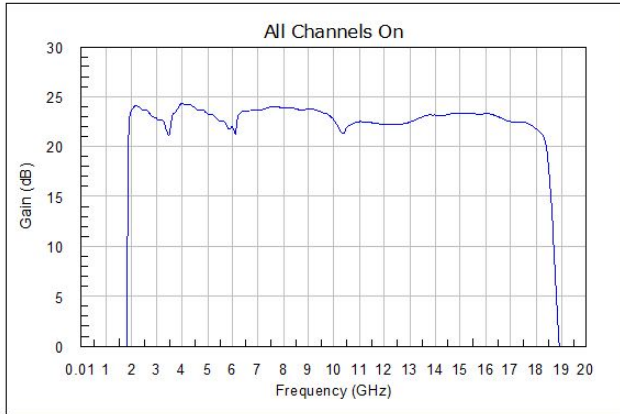

All Channels Off

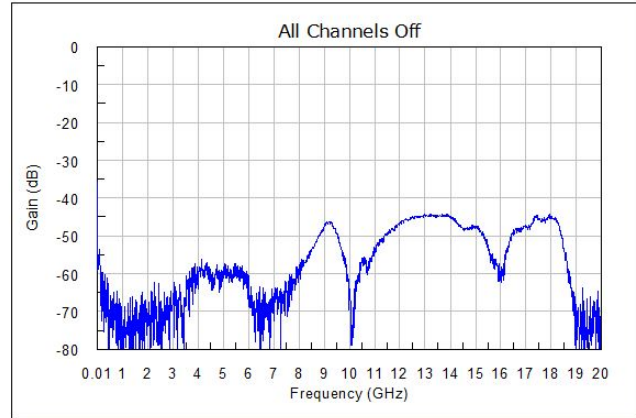

Channel 1

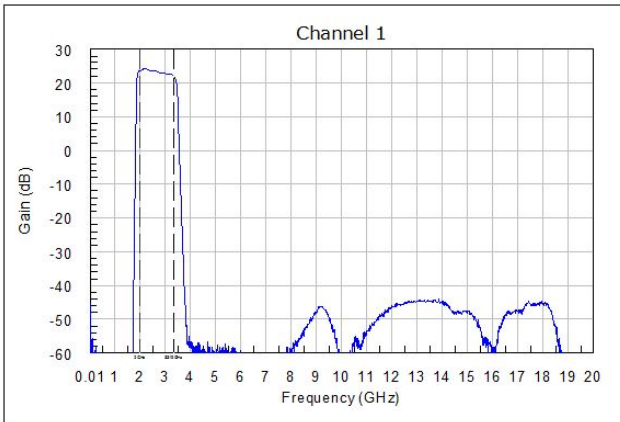

Channel 2

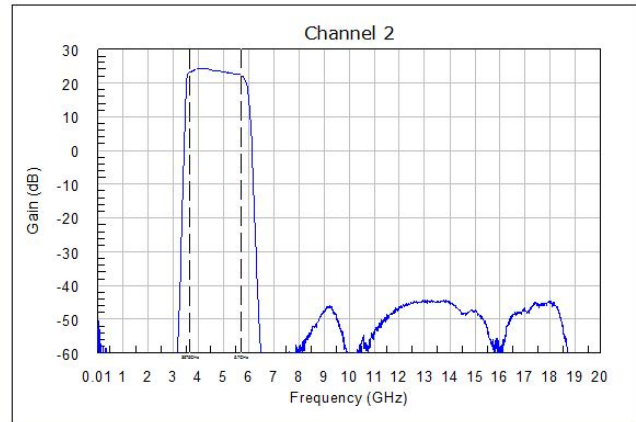

Channel 3

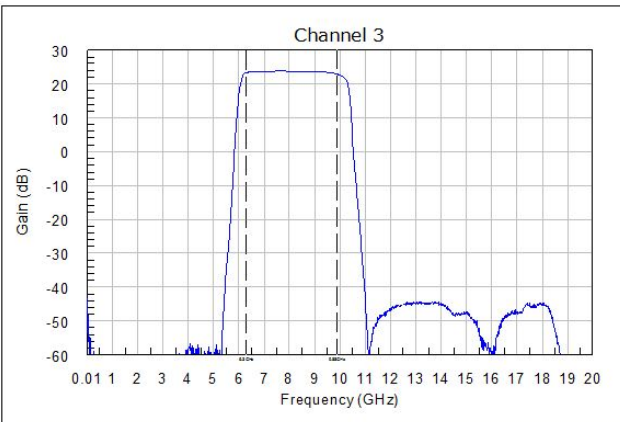

Channel 4

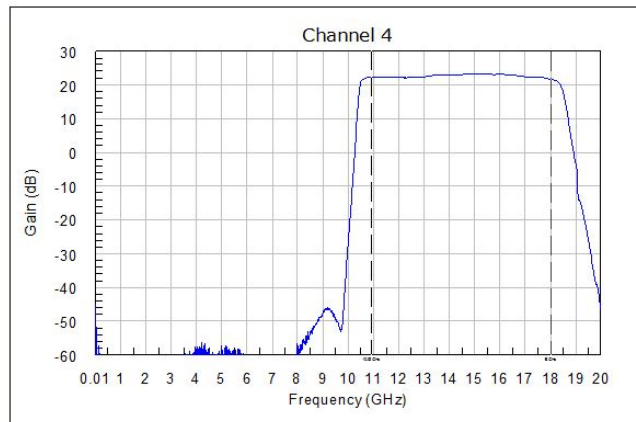

Switched Multiplexer with Integrated LNA

Features Sub-Octave Filter Bands for Excellent Harmonic Rejection

Outline Drawing

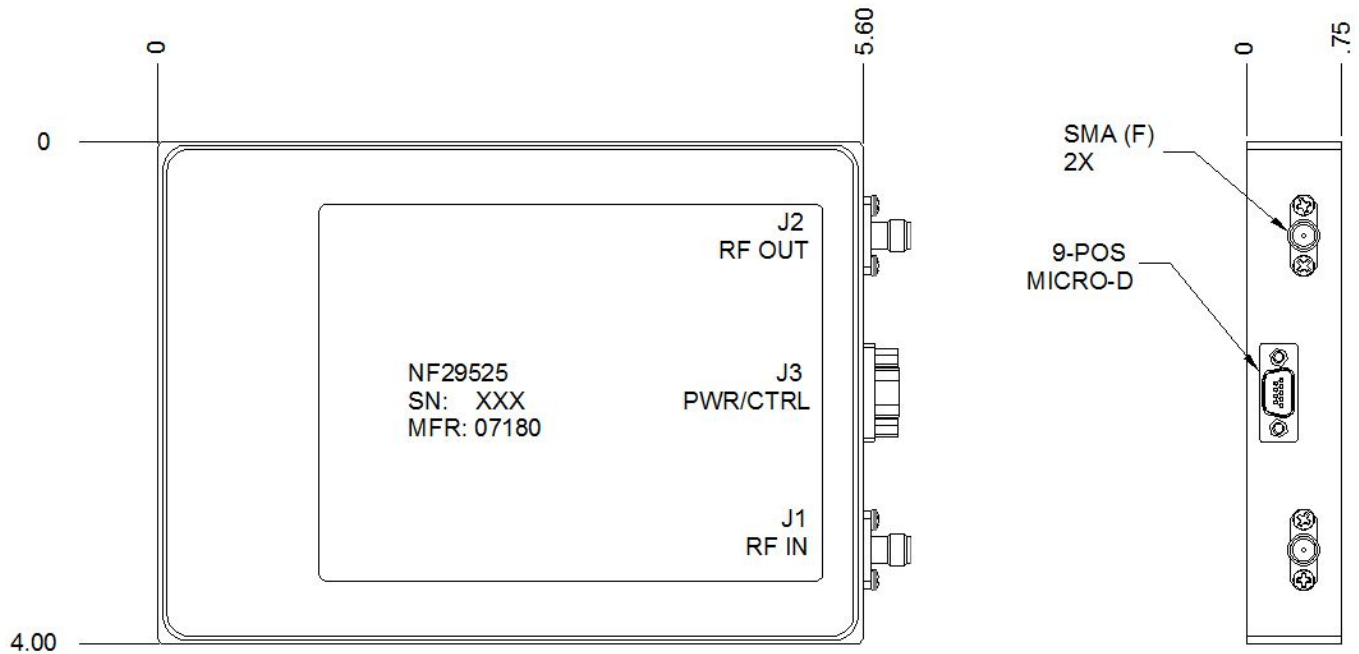

Miscellaneous:

1. API Technologies "Standard Warranty and Order Terms and Conditions" apply to all orders.
2. All specifications subject to change without notice.
3. Check "Ordering and Availability Listing" for delivery and ordering information.
4. Contact our local Manufacturers Representative for pricing.